

EXTRA P4

SPRCHOVACÍ KÚT

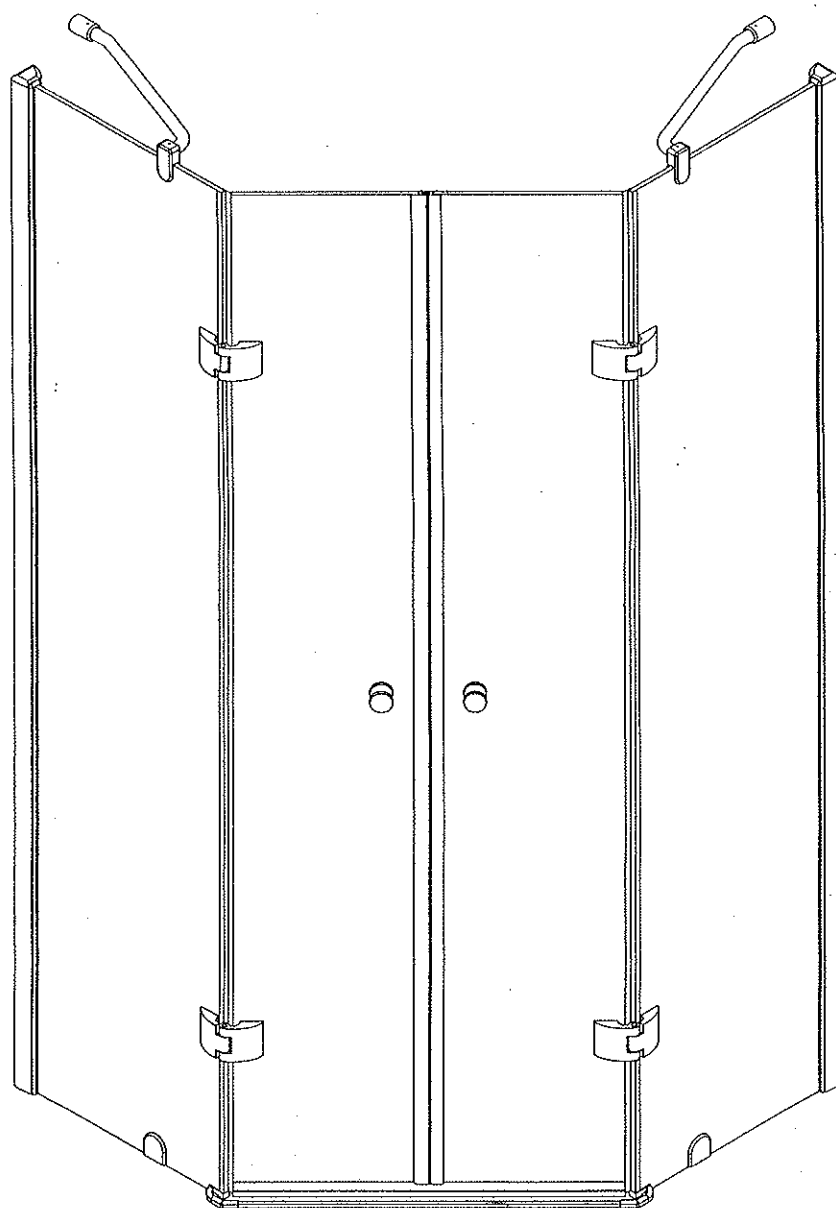

MONTÁŽNY NÁVOD

Pomocné náradie používané pri montáži :

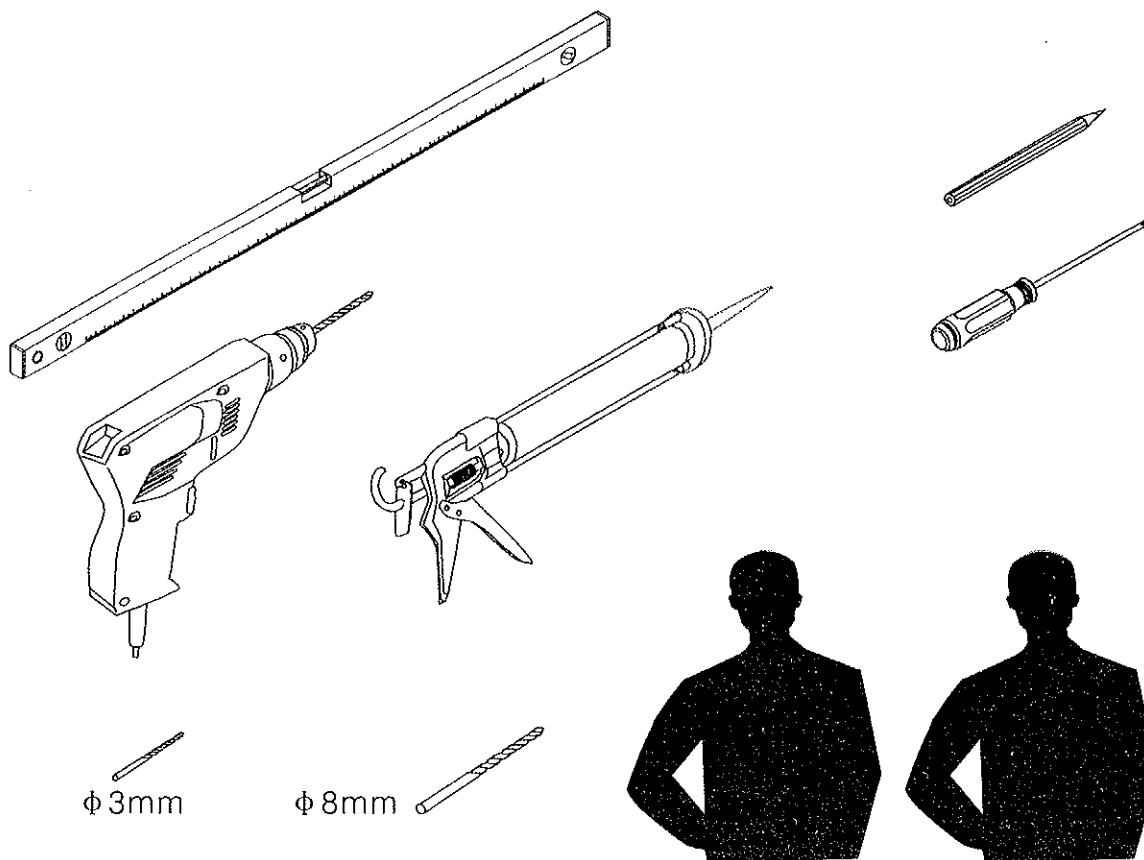



Upozornenie : K montáži sú potrebné dve osoby !!!

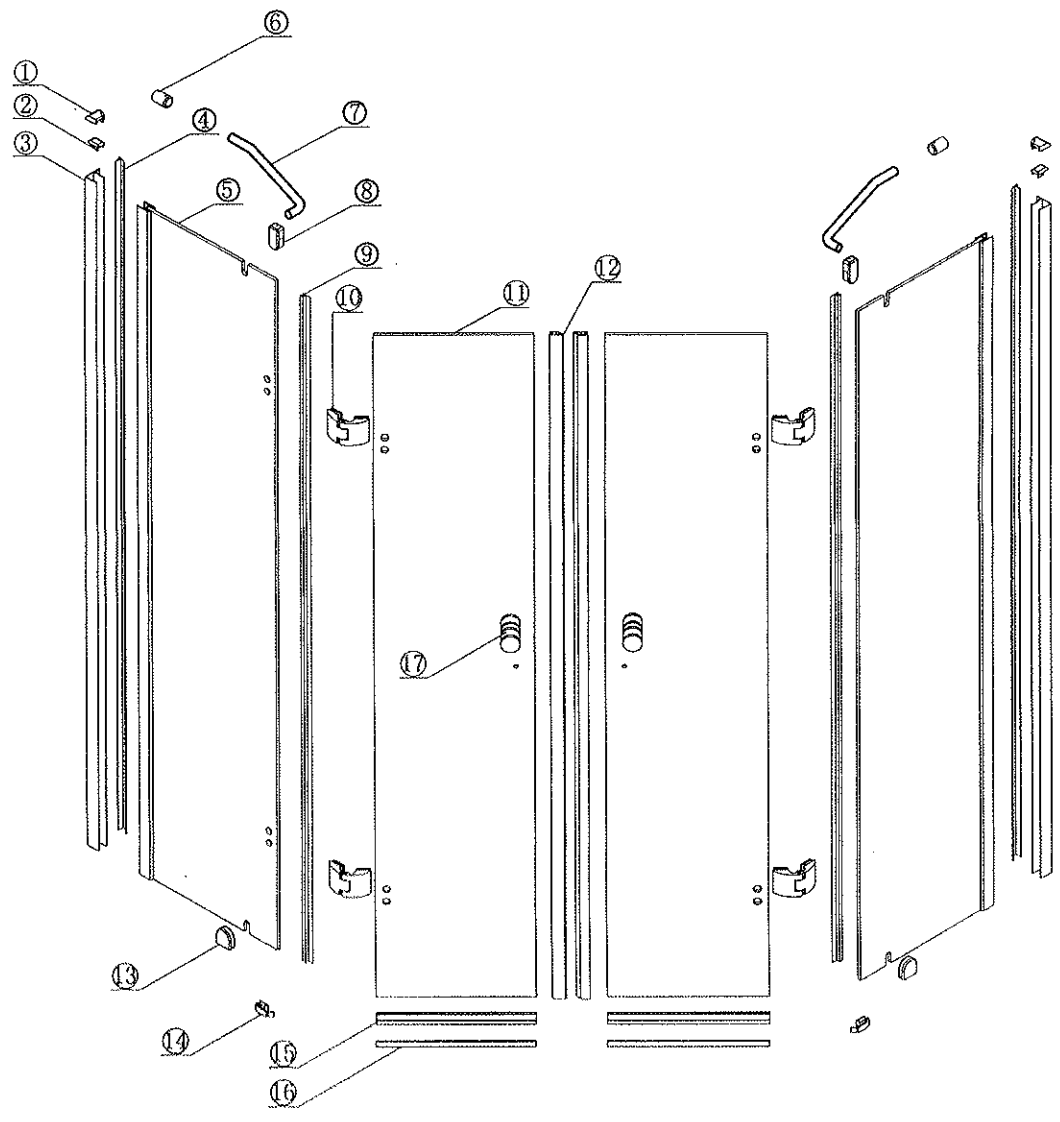



- | | | | | | | |
|--------------|-------|-----------------|---------------|--------------|---------------|---------------|
| ① x 2
L&R | ② x 2 | ③ x 2 | ④ x 2 | ⑤ x 2 | ⑥ x 2 | ⑦ x 2 |
| ⑧ x 2 | ⑨ x 2 | ⑩ x 4 | ⑪ x 2 | ⑫ x 2 | ⑬ x 2 | ⑭ x 2
L&R |
| ⑮ x 2 | ⑯ x 1 | ⑰ x 2
Handle | x 2
ST4X20 | x 8
Ø8X30 | x 8
ST5X30 | x 6
ST4X15 |

 **Upozornenie : K montáži sú potrebné dve osoby !!!** 

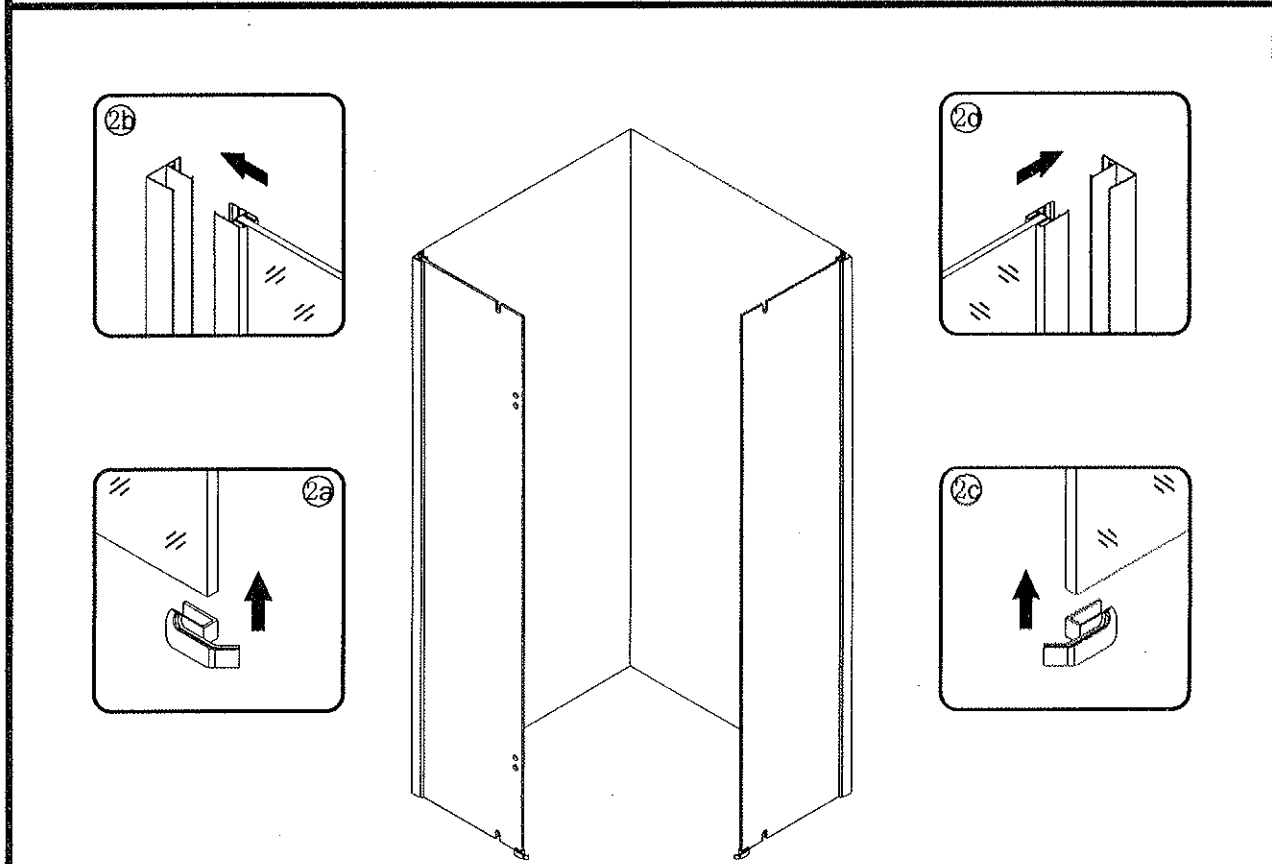
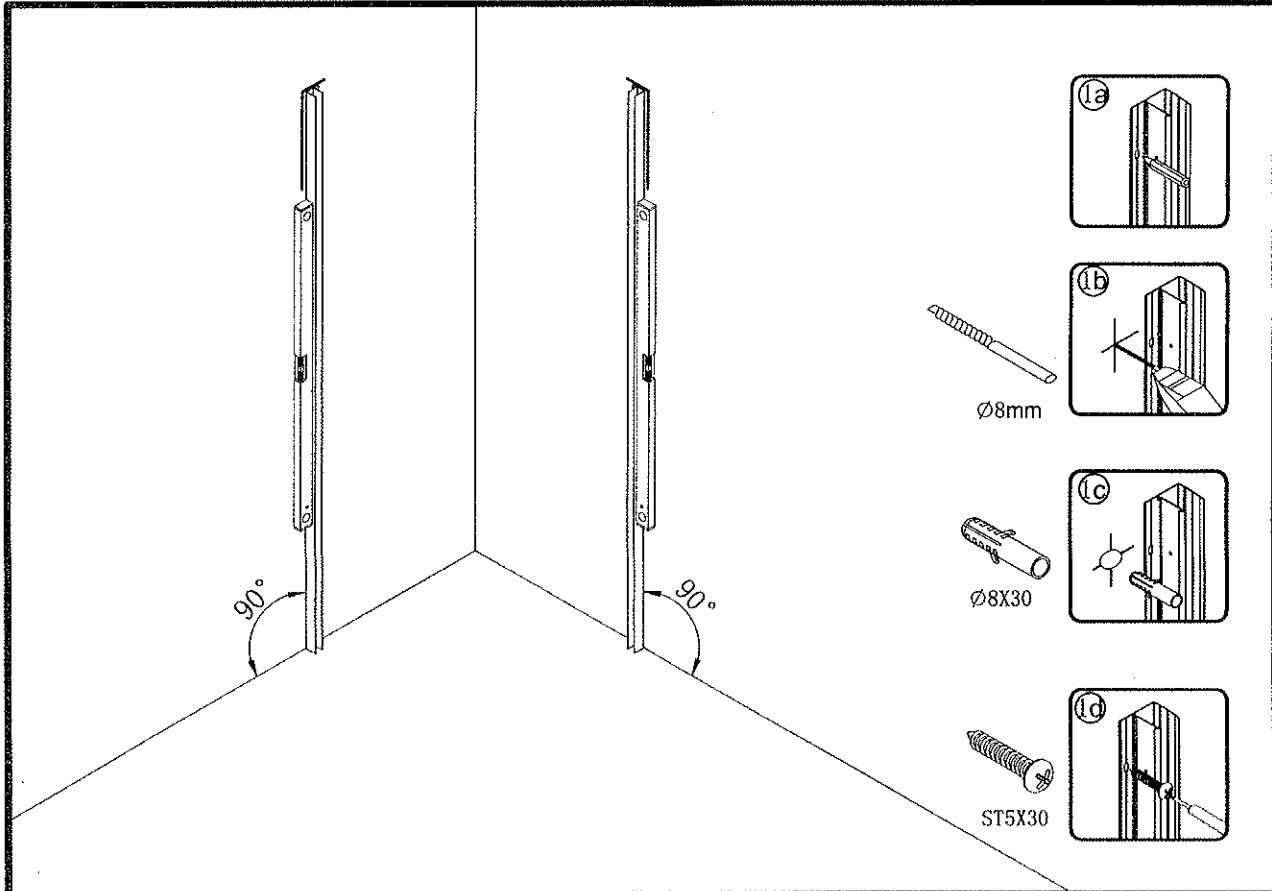

Upozornenie : K montáži sú potrebné dve osoby !!!



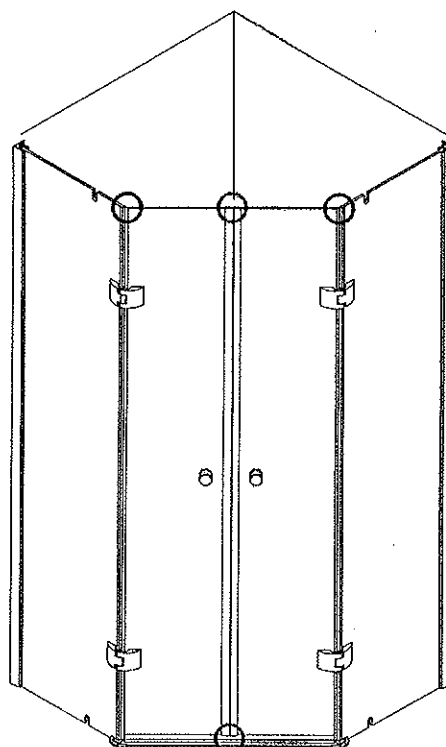
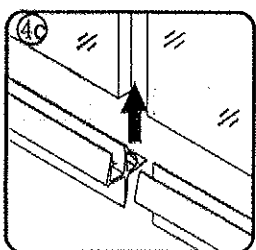
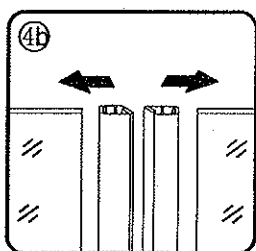
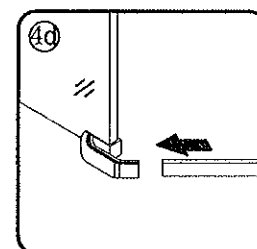
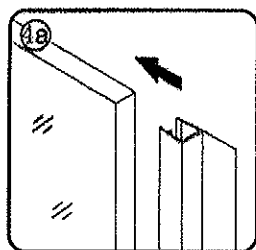
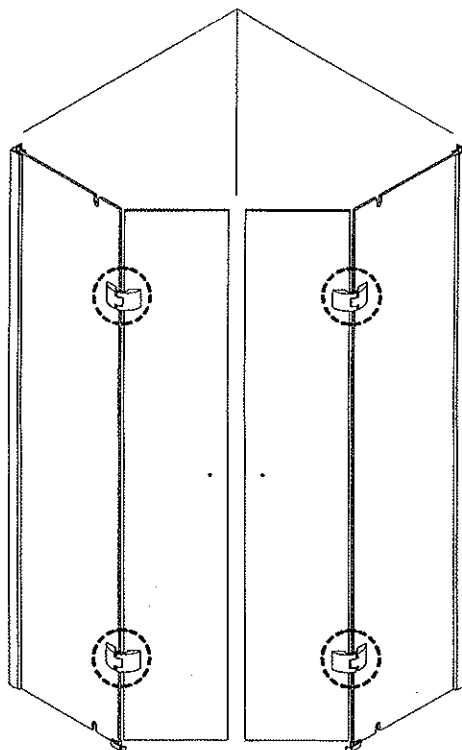
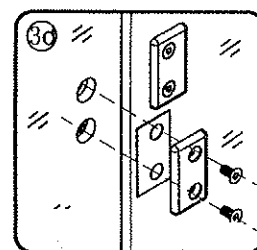
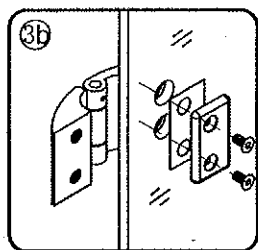
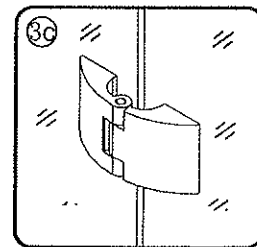
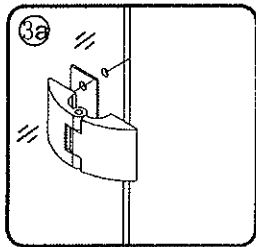

Upozornenie : K montáži sú potrebné dve osoby !!!



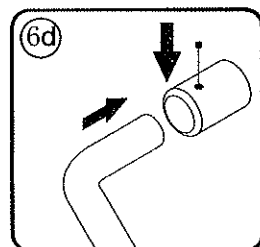
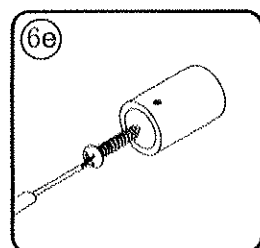
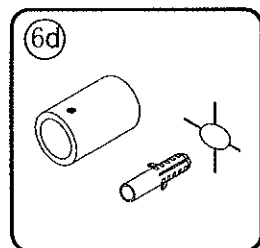
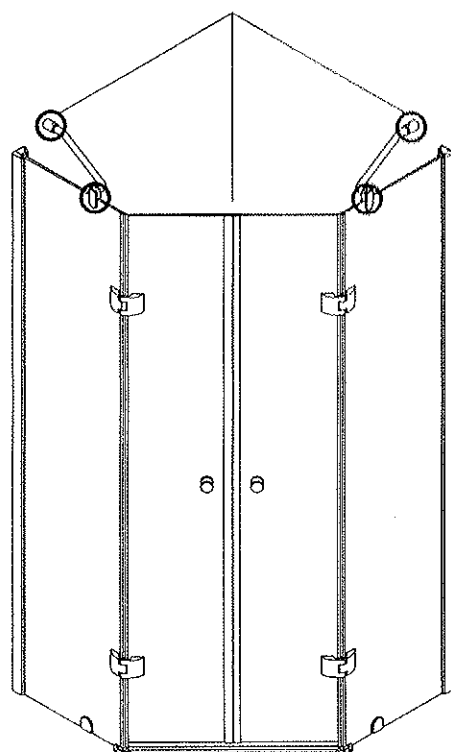
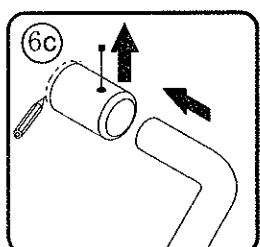
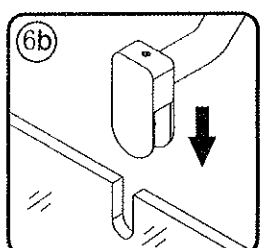
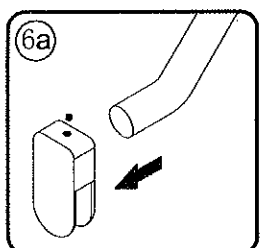
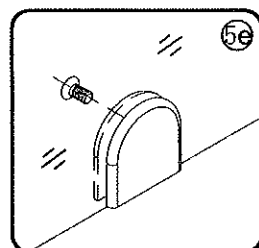
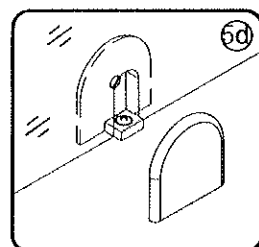
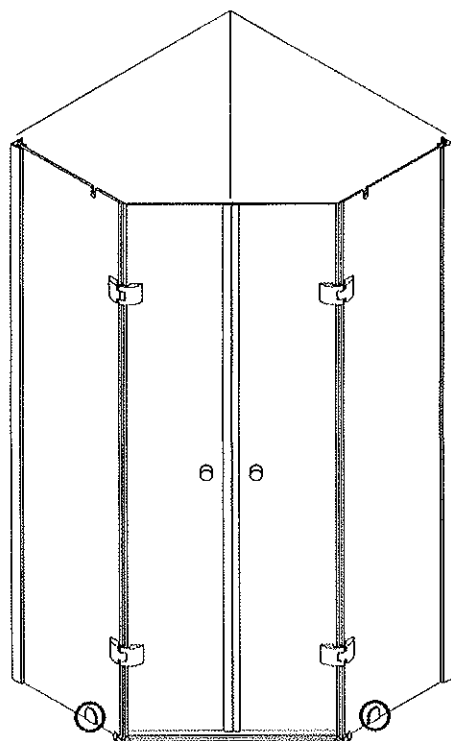
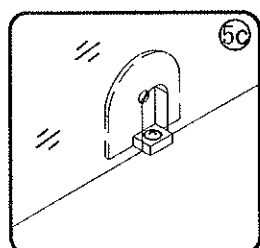
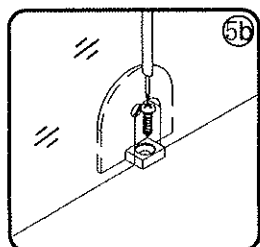
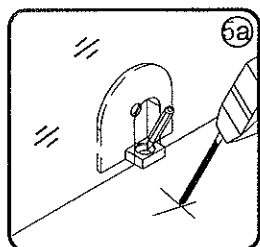

Upozornenie : K montáži sú potrebné dve osoby !!!



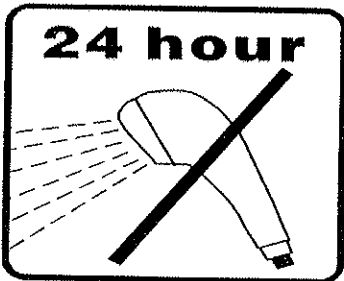
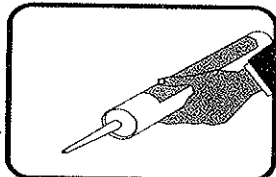
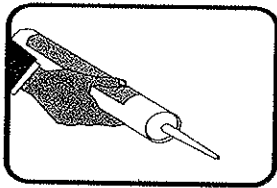
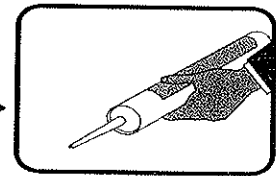
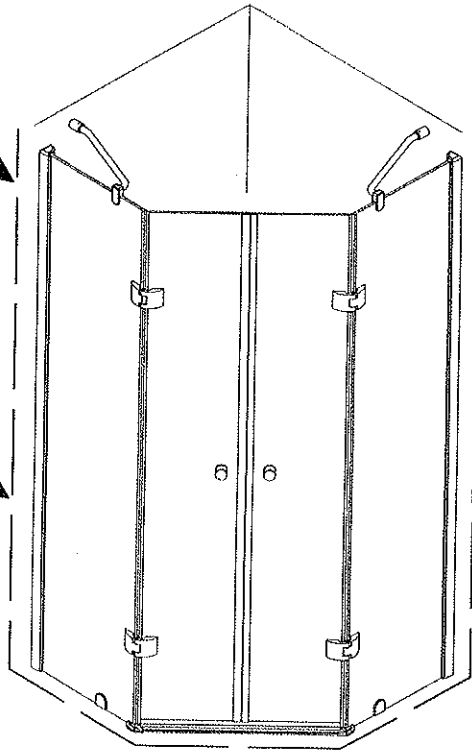
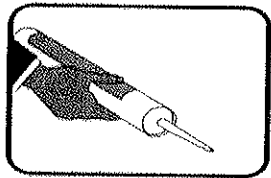
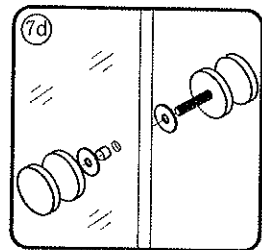
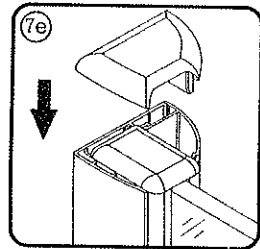
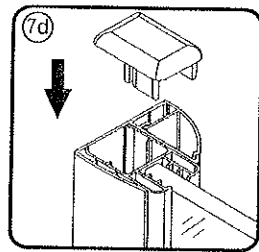
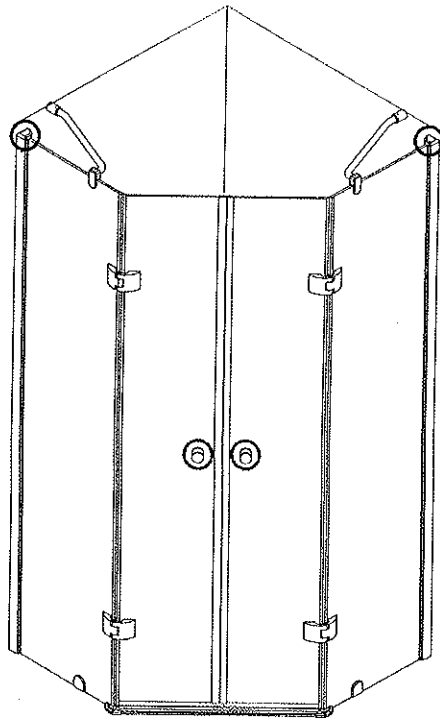
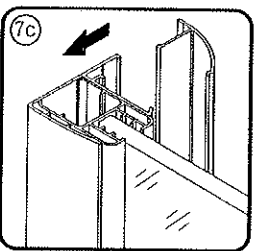
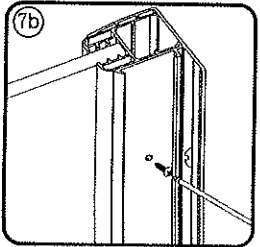
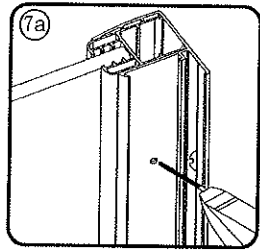

Upozornenie : K montáži sú potrebné dve osoby !!!

